

1

ARMARIO 1

(type-B)

24 DSAR-B

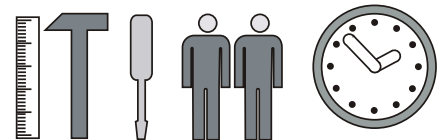
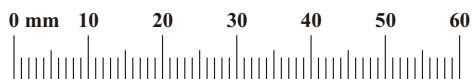
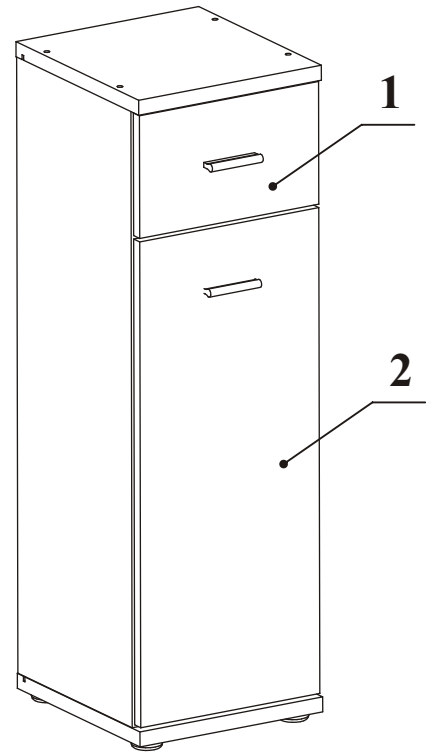
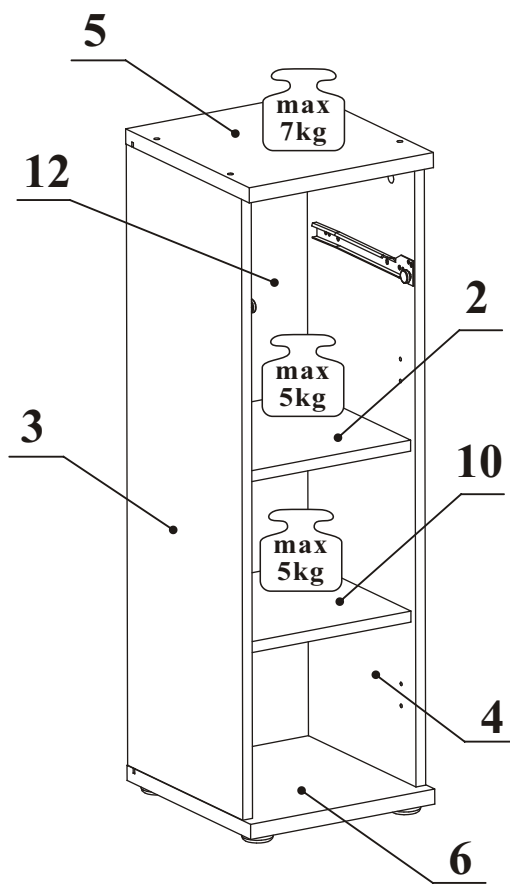
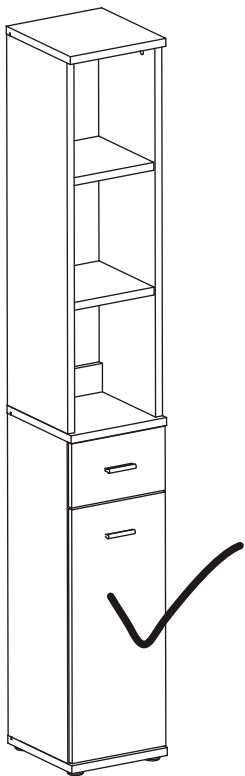

90 min

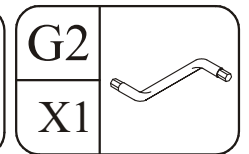
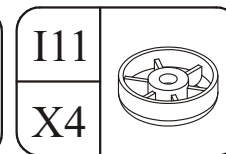
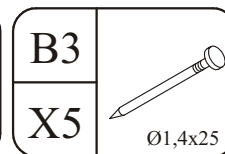
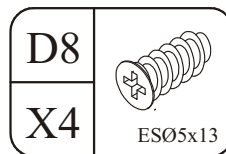
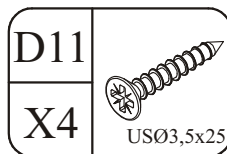
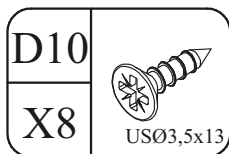
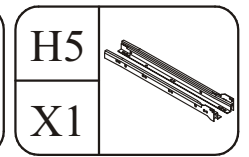
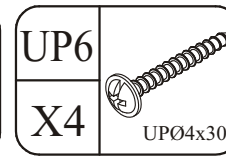
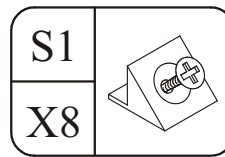
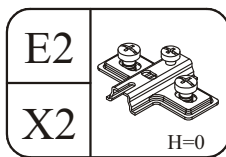
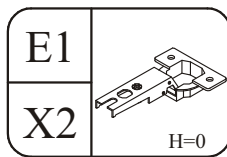
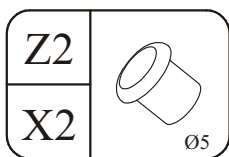
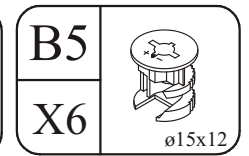
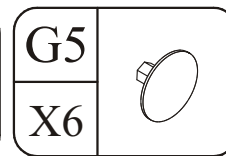
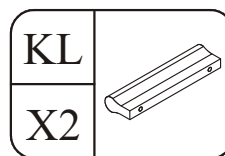
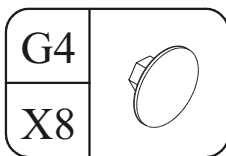
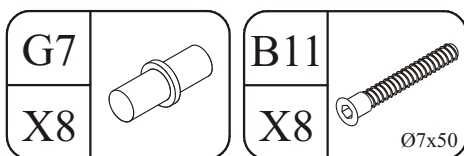
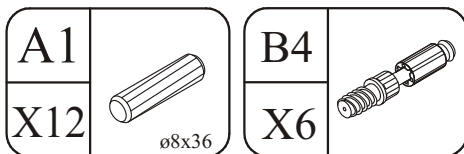

ARMARIO 1

(type-B)

24 DSAR-B

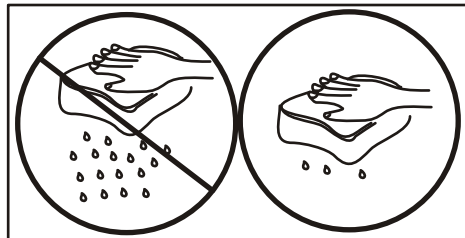
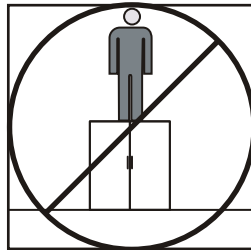
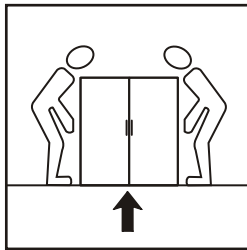
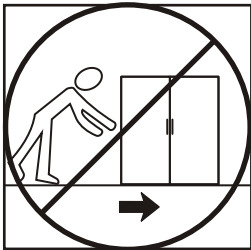
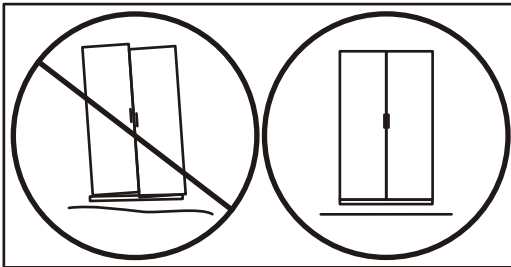
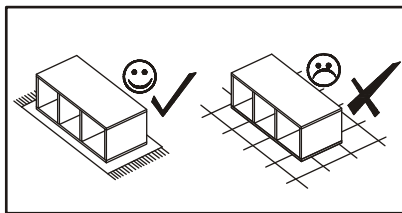
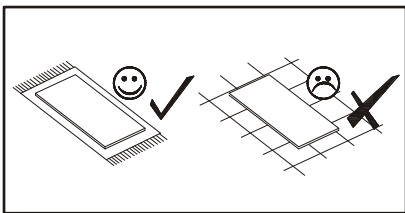
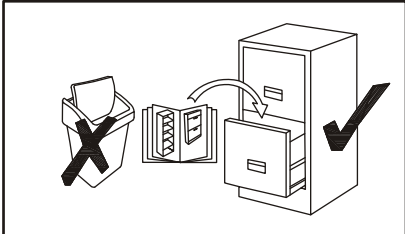
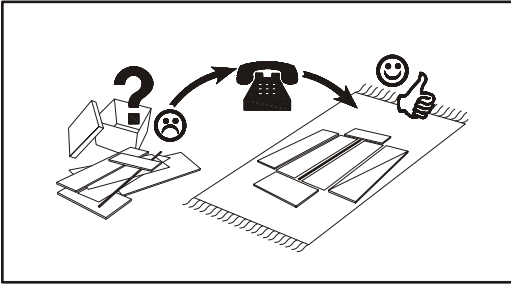

ARMARIO 1 (type-B)

24 DSAR-B

1

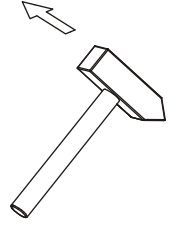
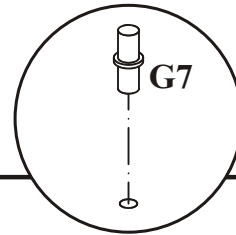
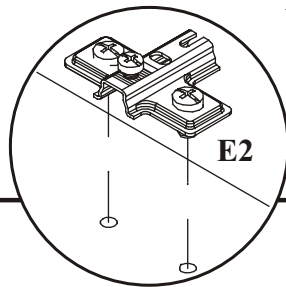
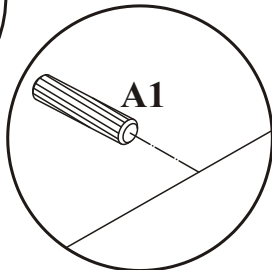
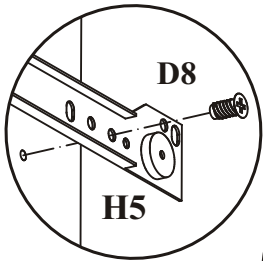
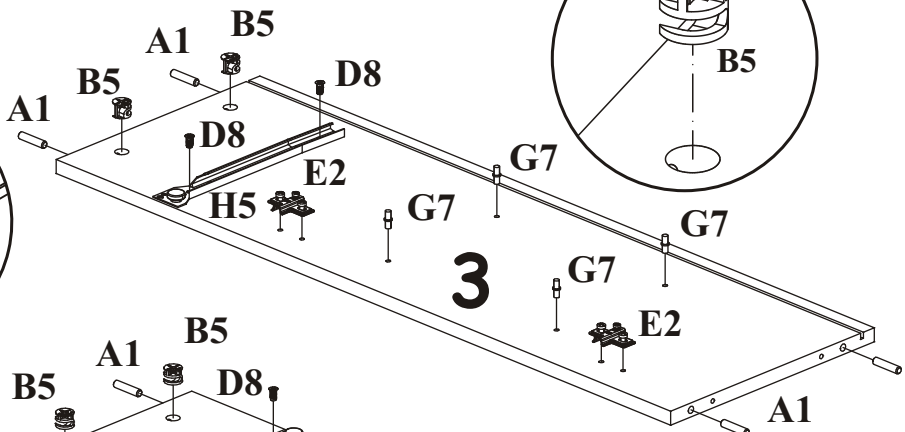
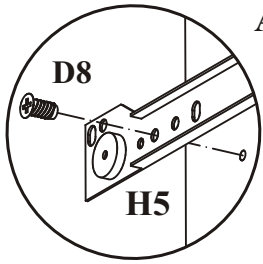

1

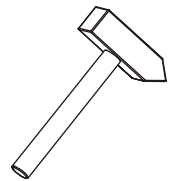
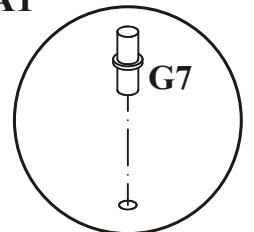
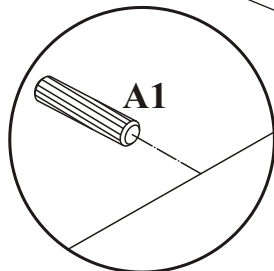
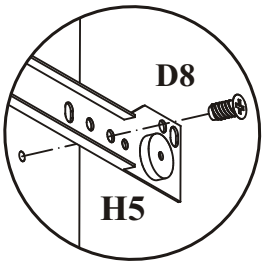
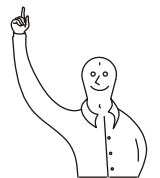
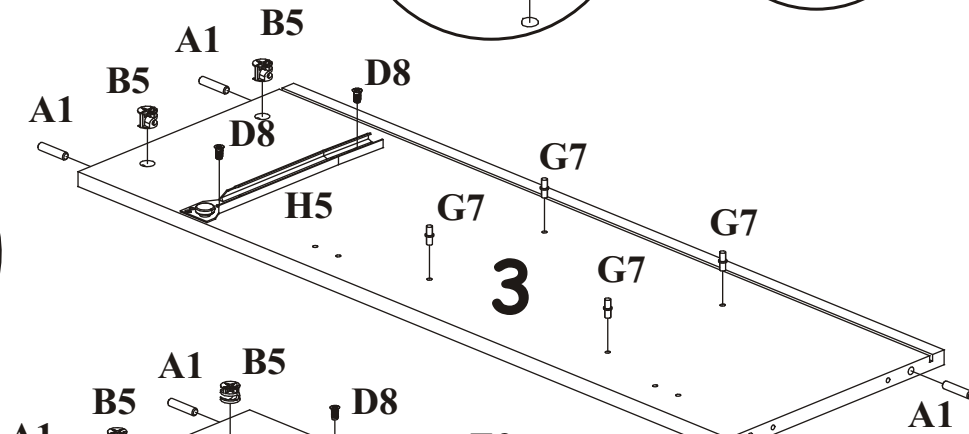
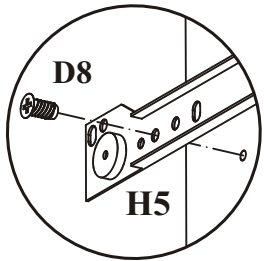

ARMARIO 1

(type-B)
UP6

24 DSAR-B

2

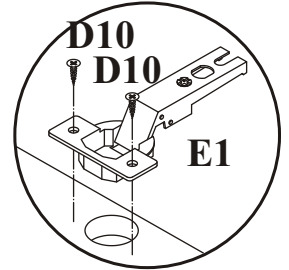
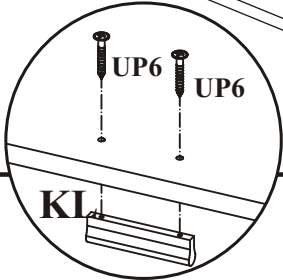
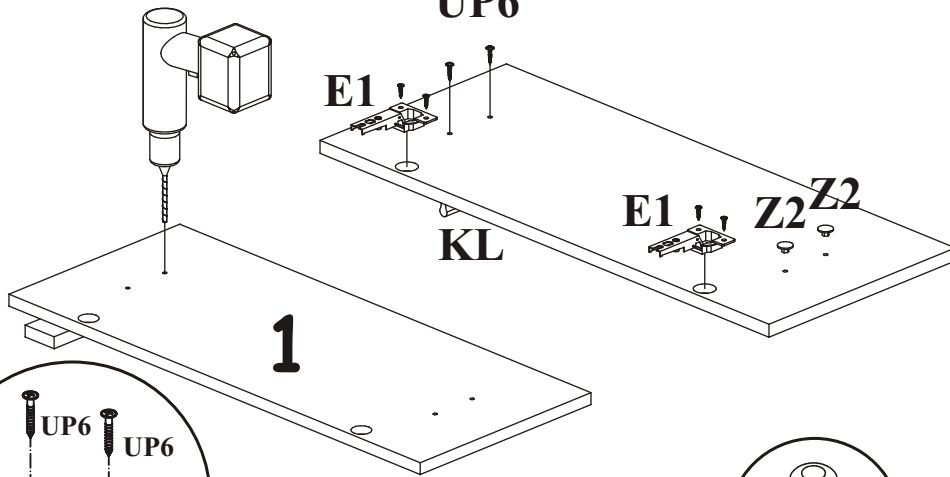

2

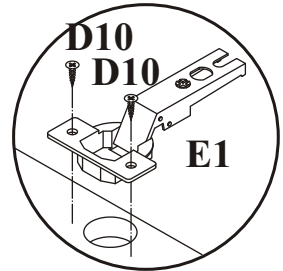
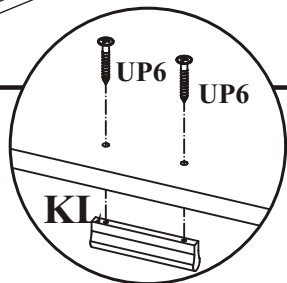
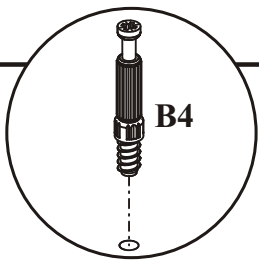
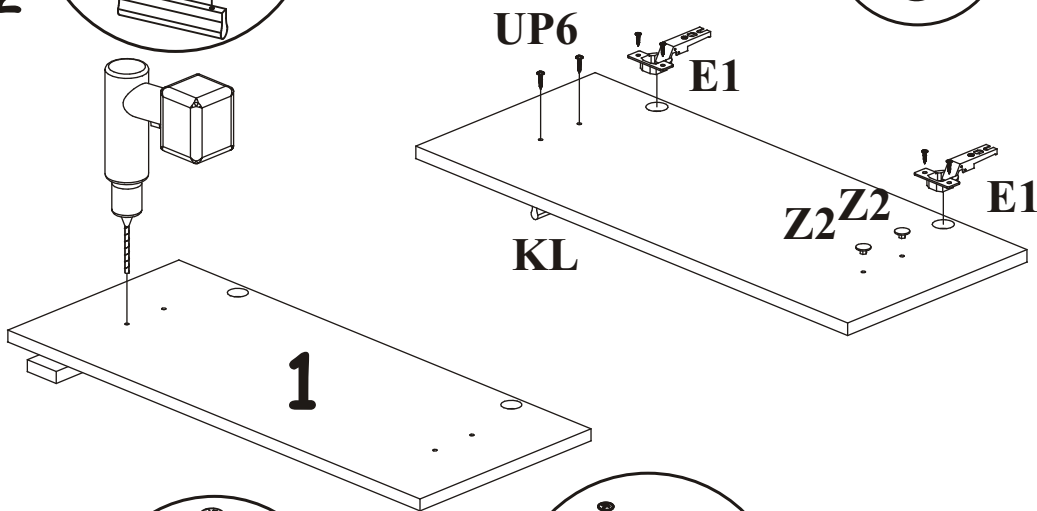

3

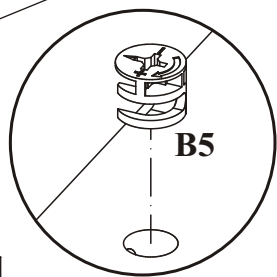
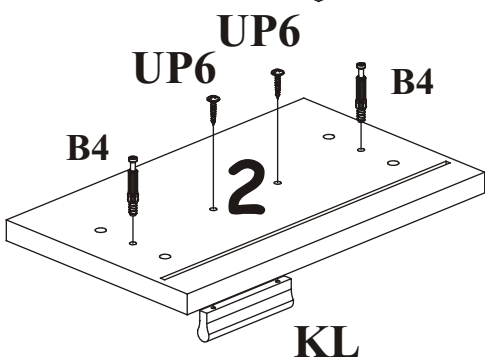
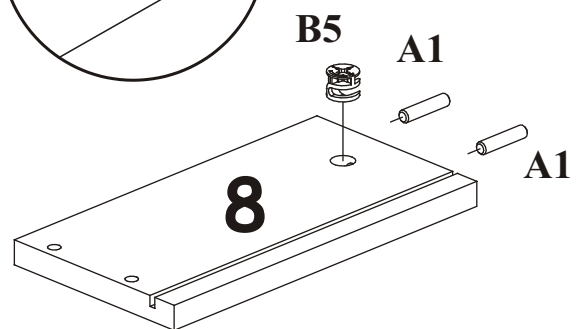
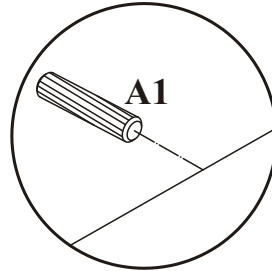
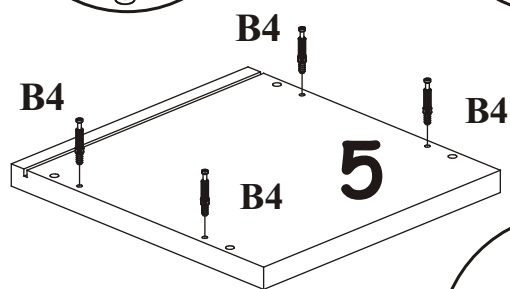

A1

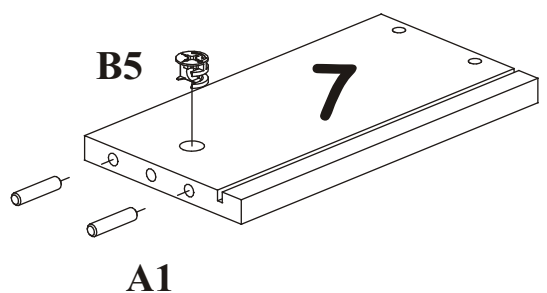

ARMARIO 1

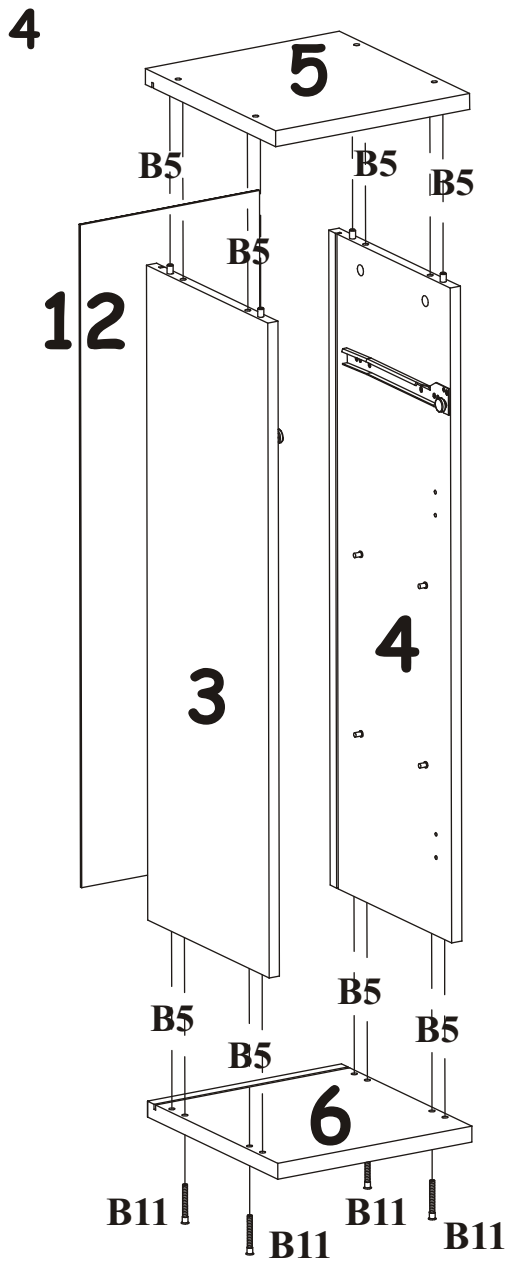

5 (type-B) 24 DSAR-B

